

# Improve PV-diesel operating management system considering sun availability time

Syafii, Muhardika, Heru Dibyo Laksono

Department of Electrical Engineering, Faculty of Engineering, Andalas University, Padang, Indonesia

---

## Article Info

### Article history:

Received Nov 29, 2022

Revised Dec 16, 2022

Accepted Jan 19, 2023

---

### Keywords:

Hybrid operating  
Management system  
Photovoltaic-diesel  
Real-time clock

---

## ABSTRACT

This paper presents a hybrid photovoltaic (PV)-diesel management system performance analysis considering weather conditions. The system is designed to operate based on charging current, battery capacity, and loading current. During charging current is decreased but the battery capacity is high, and the PV system remains supplied for low and medium loading current. When the charging current is lowered and the battery capacity is in the middle, the PV system still supplies for low loading current. However, when the charging current decreases and the battery voltage decreased below 22.3 volts, the supply instantly switches to the diesel generator. The charge current is calculated by subtracting the PV current from the load current. A real-time clock is implemented as a timer to guarantee that there is no repetitive switching throughout the night when charging from the panel is missing. The system works automatically through microcontroller control during the day for 9 hours. The improvement that has been obtained is to overcome the problem of repeated switching processes by limiting the transfer process back to PV when sunlight is not available.

*This is an open access article under the [CC BY-SA](https://creativecommons.org/licenses/by-sa/4.0/) license.*



---

## Corresponding Author:

Syafii

Department of Electrical Engineering, Faculty of Engineering, Universitas Andalas

Padang, West Sumatera, Indonesia

E-mail: syafii@eng.unand.ac.id

---

## 1. INTRODUCTION

The use of renewable energy generation will continue to increase as fossil fuel dependence is reduced [1]. Renewable energy sources will soon predominate in power generation under erratic and variable weather conditions [2]. Photovoltaic (PV) panels composed of semiconductor materials are used in solar power plants to convert solar energy into electrical energy. Due to fluctuations in solar radiation displacement from east to west and solar cell temperature, the performance of solar panels is characterized by nonlinear behavior [3]. The equatorial regions receive longer solar energy than the subtropical and polar regions [4]. Indonesia as a country in equatorial regions receives solar energy in an average of 4.8 kWh/m<sup>2</sup> [5], [6].

The advantage of solar energy is that renewable energy is inexhaustible, unlike conventional resources which are getting depleted [7]. This energy is emission-free and kind to the environment [8]. These emissions are dangerous and may result in acid rain or greenhouse gases. Utilizing renewable power has the additional advantage of not polluting the environment [9]. It only takes a few meters for this power plant to generate different locations for PV panels. The remaining space can be used for other purposes with less space.

Solar energy is unpredictable [10] energy resource or hard to predict. Natural energy-generating plants must be controlled despite their inherent unpredictability to provide sustainable energy [11]. Several

strategies are applied for stable changes in the power output of new and renewable energy installations [12]–[14]. Energy storage and management systems are widely used to address intermittent output caused by unplanned resource changes [15]. The energy supplied from fossil fuels still remains to be crucial due to its simplicity and reliability. It is still used as a supplemental renewable energy source [16], [17]. As a result, fossil fuels must still be used to supplement the supply of power from new and renewable sources. Renewable energy research has gotten a lot of attention. Several research papers have been examined ways to alter the load to match meteorological conditions [18], [19].

Previous studies have also carried out supply and demand side management for a PV system and wind generation. The algorithm based on peak load time for demand and supply side management has been simulated using MATLAB but has not been implemented in practice [20]. The fuzzy logic controller (FLC) and high order sliding mode (HSMC) methods have been applied for a smart direct current (DC)-microgrid [21]. The method based on the artificial neural network present in [22], [23]. The control strategy on the supply side for new and renewable energy sources are critical because there is a weather effect, such as solar radiation and wind speed intermittent sources [24]. The supply side management control technique above has not considered the transition time from day to night or vice versa from night to day where these conditions can result in repeated switching processes on the automatic transfer equipment. In this paper, the improvement of the system that can regulate electrical energy supply and load management in electrical energy use to enhance supply continuity as well as reduce repetitive switching during sunlight transition.

## 2. METHOD

### 2.1. PV-diesel operation management

The automation system for coordinating the operation of a solar power plant with diesel consists of an arduino control circuit and DC voltage/current sensor circuit. The Arduino control circuit employs two relay packages as switching switches between solar and diesel generators. The coordination control mechanism employed is based on the weather circumstances (sunny, overcast, rainy, or night) and the remaining battery capacity, which is detected using a DC voltage current sensor circuit. The DC voltage current sensor circuit compares the difference in the battery terminal voltage level and the charging current originating from the solar panel to determine switch transfer decisions. The power system operation coordination system operates automatically via microcontroller control based on this value. The schematic diagram of the system design is shown in Figure 1.

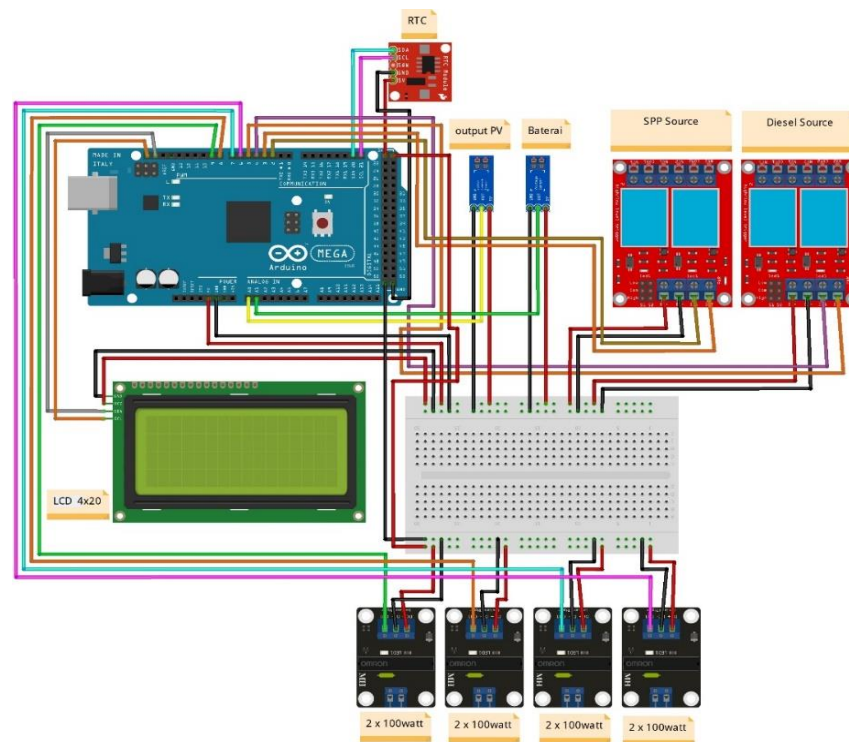

Figure 1. Schematic of system design

The characteristics of the current and voltage sensors will be used by the load management automation system to determine load distribution. This load management kit contains four solid-state relays that will activate high, medium, and low loads based on the weather. The coordination utilized after sunny, cloudy, rainy, or night weather conditions and the availability of the remaining battery capacity, which is detected using a DC voltage current sensor circuit, constitutes this load management control approach. The DC voltage current sensor circuit compares the difference between the battery terminal voltage level and the charging current from the solar panel to make switch transfer decisions. The real-time clock (RTC) is implemented as a timer, which will be an important parameter in operating management so that there is no continuous supply shift at night.

The block diagram of the operation management and loading of the hybrid power system can be seen in Figure 2. The battery terminal voltage is read by the DC voltage sensor module and the solar output current is read by the ACS712-30A current sensor to become Arduino Mega 2560 input parameters to predict battery capacity and relay switching decisions. When the remaining power in the battery is less than 30% and the output current (charging current) read by the DC current sensor is low, there will be a switch in the load supply source.

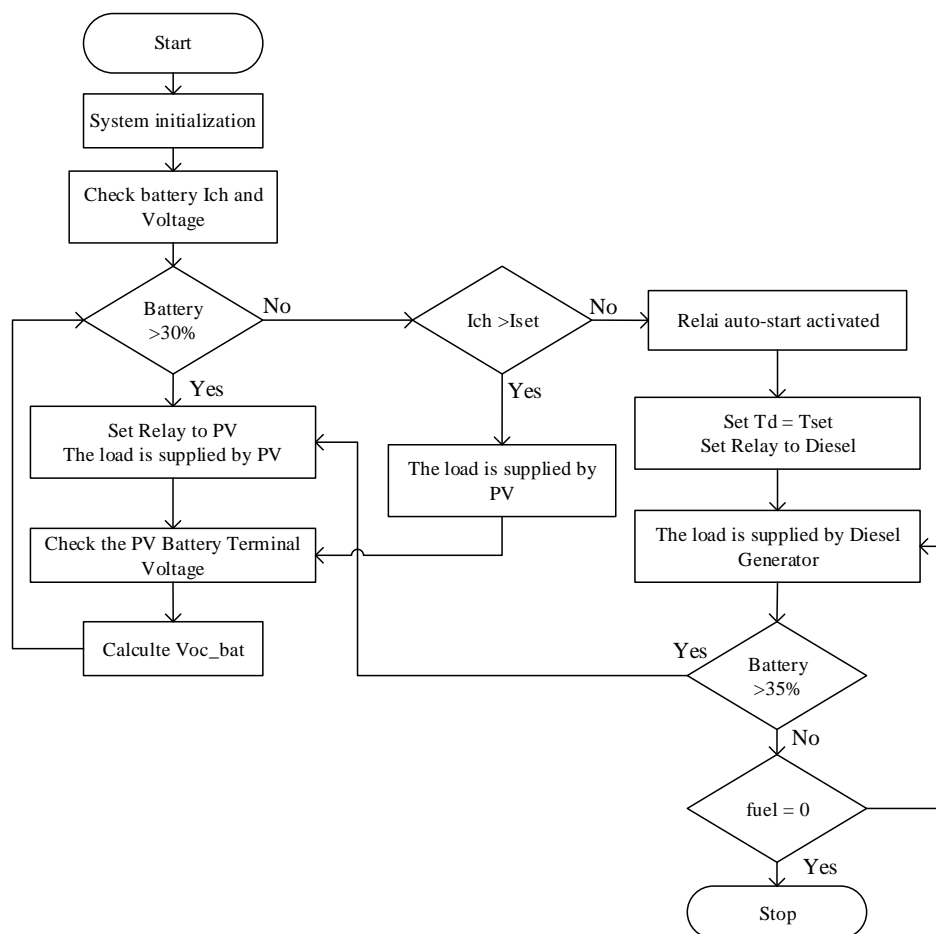

Figure 2. Block diagram of the transfer operation process of hybrid PV-diesel

In order to reduce the repetitive switching process at the afternoon and morning transition times, the system needs to consider the time of the sun's availability, namely the time of day and night. To do this, the system for the process of moving the operation of a solar-diesel power supply has been redesigned with a time schedule as shown in Figure 3. The DC voltage current sensor circuit works based on the difference in the battery terminal voltage level and the charging current originating from the solar panel and then becomes a comparison parameter for determining switch transfer decisions. Based on this value, the process of moving the power system operation works automatically through the control of the microcontroller. The process of transferring the power system source using a relay automatically during the day in a span of 9 hours starting

at 7.30 to 16.30, while the remaining 15 hours at night are locked. Thus the repeated switching process will not occur. The process of moving the automatic switch from this research can also be applied to the PV system on the grid to reduce the repetitive synchronization process during the transition in the morning and evening.

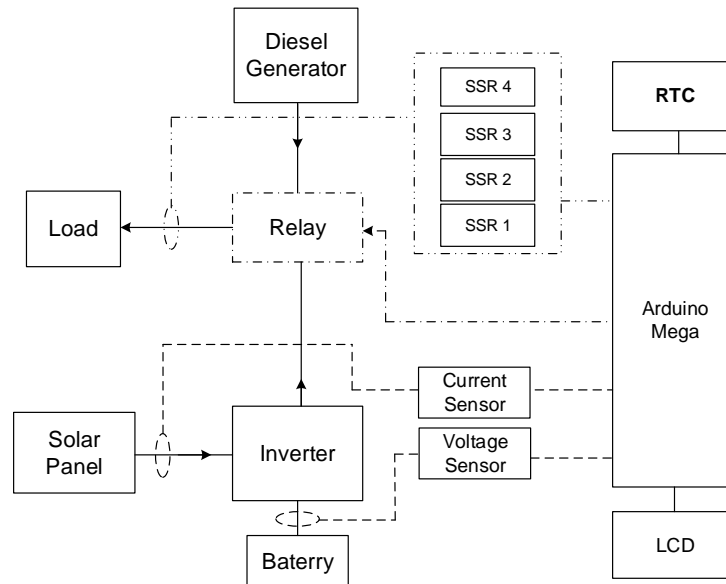

Figure 3. Hybrid PV-diesel operating management system with time schedule

In the condition that the battery capacity increases by more than 35% and the available output (charging) current exceeds the setting current, the Arduino Mega 2560 will command the relay to move the power source from the diesel generator back to the PV system. After 5 minutes the system is supplied by the PV system. The relay will return to work switching off the diesel generator. This is done so that there is no disconnection in the supply of electrical energy when there is a transfer of energy supply sources from generators as backup energy to solar power plants as primary energy. The loading side will only move according to weather conditions represented by the current and voltage sensors' output to move high, medium, and low load lines.

## 2.2. Test system

The solar array performance in this study uses sensors as parameters to select supply and load lines, as battery voltage and PV current readings use sensors as media. The ACS712 30A sensor measures PV current and the DC voltage sensor measures battery voltage. DC voltage sensors use the principle of voltage divider operation. This module can drop the input voltage down to 5 times the supply voltage with 30 k for R1 and 7.5 k for R2 and 25 V for the maximum voltage rating. It uses Vout default connection whereas Arduino's input voltage limit is 5 V, so it can measure battery voltages up to 25 V DC. The roof PV current reading is obtained by reading the ACS712 30 A sensor.

The DC voltage sensor and DC current sensor are calibrated by comparing manual measurements with a multimeter and provide measurement data that are utilized as supply and load displacement characteristics. The validation of the voltage sensor is carried out so that the output of the reading can be the same and precise as the measuring instrument to get the right voltage value. Voltage is one of the important parameters in the operation management of this hybrid plant. It can be seen in Table 1, the difference between the voltage sensor output and the voltmeter is 0.01 in average.

Current sensor validation is carried out so that the output of the readings can be the same and precise with the measuring instrument to get the right current value. Current is one of the important parameters in the management of the operation of this hybrid power plant. It can be seen in Table 2, the difference between the current sensor output and ampermeter in average is 0.02. The validation results of the sensor readings show that the difference in readings is still within the accepted limits as recommended in the international electrotechnical commission (IEC) standards [25].

Table 1. Voltage sensor validation with voltmeter

No	Voltage sensor (V)	Voltmeter (V)	Difference
1	24.98	25	0.02
2	24.8	24.81	0.01
3	24.79	24.8	0.01
4	24.77	24.79	0.02
5	24.78	24.8	0.02
6	24.75	24.76	0.01
7	24.32	24.33	0.01
8	23.73	23.73	0.00
9	22.66	22.65	0.01
10	22	22.01	0.01
Average difference			0.01

Table 2. Validation of current sensor with ammeter

No	ACS712 (A)	Amperemeter (A)	Difference
1	7.3	7.28	0.02
2	7	6.97	0.03
3	6.8	6.81	0.01
4	6.75	6.77	0.02
5	6.43	6.41	0.02
6	6.41	6.38	0.03
7	5.93	5.91	0.02
8	5.47	5.45	0.02
9	5.21	5.23	0.01
10	4.97	5.01	0.04
Average difference			0.02

### 3. RESULTS AND DISCUSSION

The process of transferring the source to diesel generator is carried out using a 220 V relay which is controlled by the controller automatically, while the return back to PV process can only be carried out during the day from 7.30 am to 16.30 pm or for a period of 9 hours. As long as the fuel oil for the diesel generator is available at night after the transfer process has worked, the system load will still be supplied by the diesel generator. Only if the fuel for the diesel generator has run out, the system will turn off. Operation and load management is based on the output values of the current and voltage sensors. Supply and load transfers will vary according to weather conditions. Sunny, cloudy, rainy weather conditions will be represented by the current and voltage sensor outputs. In order to avoid supply shifts at night, the RTC will function as a timer to determine supply transfers according to the settings that have been made.

The data collection was carried out on the rooftop of the Department of Electrical Engineering Building of Universitas Andalas. The supply transfer test can be seen in Figure 4. Where the supply transfer occurs when the weather is cloudy and the battery availability is running low. Shortly after switching the supply, the battery voltage rises again, but does not cause the switching process because the battery charging current tends to decrease and the battery voltage is set to slightly exceed the voltage when switching occurs. The transfer of supply from the PV to the diesel generator will occur when the value of the remaining voltage on the battery has reached the limit to transfer the supply so that the battery does not discharge excessively as shown in Figure 4. This is so that the battery is more durable and there is no disconnection of the supply to the load.

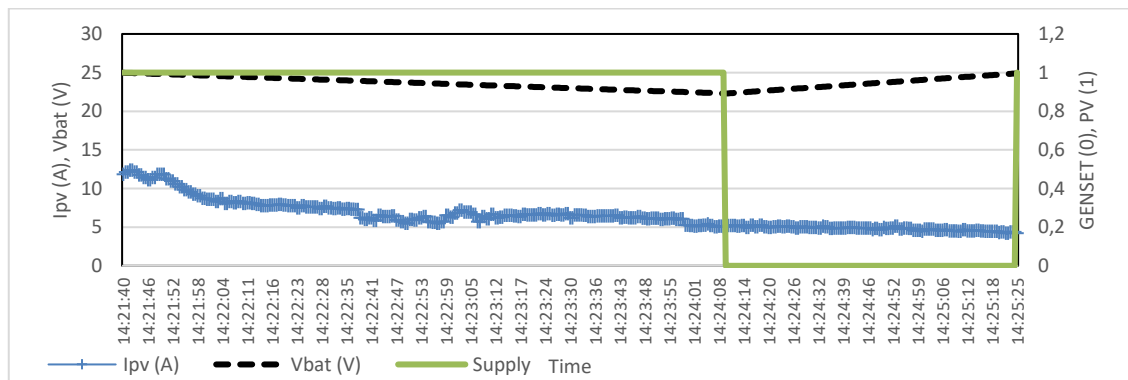

Figure 4. Transfer of supply from PV to diesel generator

The load shift is seen when the charging current and voltage on the battery decrease so that the system also adjusts the load to the available supply as shown in Figure 5. The red dotted line shows the load transfer condition when the setting is reached. Load transfer from high load to medium load occurs at Ipv 7.32 A and Vbat 24 V. Switching from medium load to low load occurs at Ipv 5.18 A and Vbat 22.30. Immediately after switching from PV to diesel generator, the system switches the supply to the diesel generator. When the system supply shifts from PV to diesel generator, it can be seen that the system can turn on the load to a maximum of 800 watts. This transfer occurred in a short time because the system was still getting supply from the solar panels so the battery charging condition still occurred because there was still sunlight. At night there is no sunlight, so PV does not generate electricity anymore. The switch works to move the source back to the PV system automatically during the day after the battery capacity exceeds 25% within 9 hours and is locked for 15 hours at night.

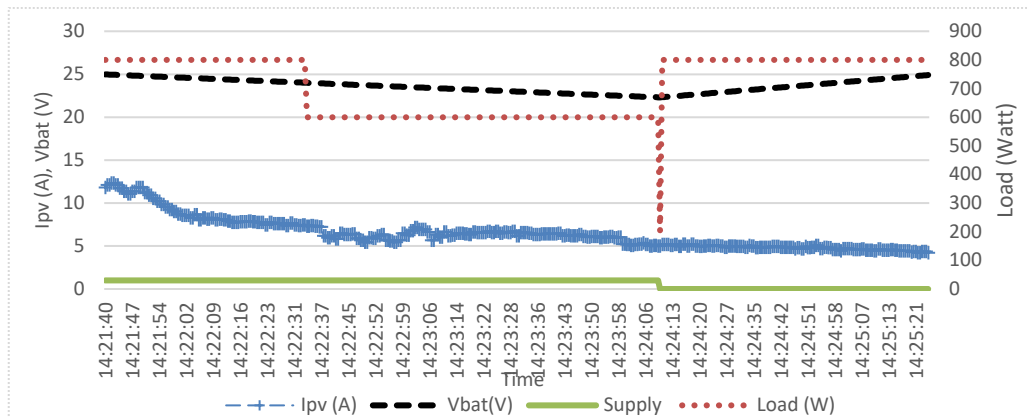

Figure 5. Load transfer in a hybrid system

#### 4. CONCLUSION

The operating and loading management system of the hybrid power system has been designed according to the sunlight availability time. The operating control mechanism is built using 2 pairs of relays to switch the supply from PV to diesel generators and vice versa. While the load control is built using 4 solid-state relays to switch from low, medium, and high load options. In addition, the system is also equipped with an RTC to set the system's operating time when the sun is available. The test is carried out using a load of 8 lamps which are arranged in such a way as to be able to represent the available load options. The test results show that system can be served by a PV system depending on the current and voltage on the battery. The supply and load switching decision occurs as the PV current decreases, the battery voltage decreases due to discharge, and then reaches supply and load transfer regulation. This time scheduling mechanism is needed to ensure that repeated switching does not occur at night, even if the battery capacity returns to more than 25%. At night for 15 hours the controller is scheduled to not activate the relay to move the generator source from the diesel generator to the PV system. Using the coordination system in a PV-diesel hybrid generator will reduce fuel consumption, increase renewable sources and reduce carbon emissions.

#### ACKNOWLEDGEMENTS

This research was funded by DRTPM Ministry of Education, Culture, Research and Technology in accordance with research contract number: 011/E5/PG.02.00.PT/2022 Fiscal Year 2022.



#### REFERENCES

- [1] A. Zohrabian, S. L. Plata, D. M. Kim, A. E. Childress, and K. T. Sanders, "Leveraging the water-energy nexus to derive benefits for the electric grid through demand-side management in the water supply and wastewater sectors," *WIREs Water*, vol. 8, no. 3, 2021, doi: 10.1002/wat2.1510.
- [2] N. Helistö, J. Kiviluoma, G. Morales-España, and C. O'Dwyer, "Impact of operational details and temporal representations on investment planning in energy systems dominated by wind and solar," *Appl. Energy*, vol. 290, p. 116712, 2021, doi: 10.1016/j.apenergy.2021.116712.
- [3] S. Guo, R. Abbassi, H. Jerbi, A. Rezvani, and K. Suzuki, "Efficient maximum power point tracking for a photovoltaic using hybrid shuffled frog-leaping and pattern search algorithm under changing environmental conditions," *Journal of Cleaner Production*, vol. 297, p. 126573, May 2021, doi: 10.1016/j.jclepro.2021.126573.
- [4] O. A. Rosyid, "Comparative performance testing of photovoltaic modules in tropical climates of Indonesia," in *AIP Conference Proceedings*, 2016, doi: 10.1063/1.4941865.
- [5] Syafii, Zaini, D. Juliandri, and Wati, "Design and Economic Analysis of Grid- Connected Photovoltaic on Electrical Engineering Building in Universitas Andalas," *Int. J. of Engineering and Technology*, vol. 10, no. 4, pp. 1093–1101, 2018, doi: 10.21817/ijet/2018/v10i4/181004029.
- [6] M.-Q. Dang, "Solar Energy Potential in Indonesia," *19Th Int. Conf. Young Sci.*, p. 199, Sep. 2017.
- [7] S. R. Salkuti, "Emerging and Advanced Green Energy Technologies for Sustainable and Resilient Future Grid," *Energies*, vol. 15, no. 18, p. 6667, Sep. 2022, doi: 10.3390/en15186667.
- [8] V. P. Chaudhary, R. Chandra, R. Chaudhary, and R. Bhattacharyya, "Global warming potential and energy dynamics of conservation tillage practices for different rabi crops in the Indo-Gangetic Plains," *Journal of Environmental Management*, vol. 296, p. 113182, Oct. 2021, doi: 10.1016/j.jenvman.2021.113182.
- [9] M. M. Bertsiou and E. Baltas, "Power to Hydrogen and Power to Water Using Wind Energy," *Wind*, vol. 2, no. 2, pp. 305–324, May 2022, doi: 10.3390/wind2020017.
- [10] J. Blondeau and J. Mertens, "Impact of intermittent renewable energy production on specific CO<sub>2</sub> and NO emissions from large scale gas-fired combined cycles," *Journal of Cleaner Production*, vol. 221, pp. 261–270, Jun. 2019, doi: 10.1016/j.jclepro.2019.02.182.
- [11] A. Hasankhani and S. M. Hakimi, "Stochastic energy management of smart microgrid with intermittent renewable energy resources in electricity market," *Energy*, vol. 219, p. 119668, Mar. 2021, doi: 10.1016/j.energy.2020.119668.



- [12] B. A. Basit and J.-W. Jung, "Recent developments and future research recommendations of control strategies for wind and solar PV energy systems," *Energy Reports*, vol. 8, pp. 14318–14346, Nov. 2022, doi: 10.1016/j.egy.2022.10.395.
- [13] S. Shivashankar, S. Mekhilef, H. Mokhlis, and M. Karimi, "Mitigating methods of power fluctuation of photovoltaic (PV) sources – A review," *Renewable and Sustainable Energy Reviews*, vol. 59, pp. 1170–1184, Jun. 2016, doi: 10.1016/j.rser.2016.01.059.
- [14] J. Li *et al.*, "How to make better use of intermittent and variable energy? A review of wind and photovoltaic power consumption in China," *Renewable and Sustainable Energy Reviews*, vol. 137, p. 110626, Mar. 2021, doi: 10.1016/j.rser.2020.110626.
- [15] T. Weckesser, D. F. Dominković, E. M. V. Blomgren, A. Schledom, and H. Madsen, "Renewable Energy Communities: Optimal sizing and distribution grid impact of photo-voltaics and battery storage," *Appl. Energy*, vol. 301, p. 117408, 2021, doi: 10.1016/j.apenergy.2021.117408.
- [16] T. Aboumahboub *et al.*, "Cost-optimal configuration of a renewable-based Australian power system," *Renewable Energy and Power Quality Journal*, vol. 18, pp. 729–734, Jun. 2020, doi: 10.24084/repqj18.482.
- [17] A. Mujanović, T. Konjić, and A. Dedić, "Electricity efficiency of auxiliary power systems in coal thermal power plant," *Int. j. of electrical and computer engineering systems*, vol. 11, no. 2, pp. 101–110, Jul. 2020, doi: 10.32985/ijeces.11.2.5.
- [18] Syafii, Muhandika, and A. Pawawoi, "Performance Analysis of PV Loading Management System based on Weather Conditions," in *2022 4th International Conference on Smart Systems and Inventive Technology (ICSSIT)*, Jan. 2022, doi: 10.1109/icssit53264.2022.9716369.
- [19] Syafii, Y. Mayura, and A. E. Gazaly, "Characteristics of Lead-Acid Battery Charging and Discharging Against Residential Load in Tropical Area," in *2019 16th International Conference on Quality in Research (QIR): International Symposium on Electrical and Computer Engineering*, Jul. 2019, doi: 10.1109/qir.2019.8898277.
- [20] S. Kazmi *et al.*, "Balancing Demand and Supply of Energy for Smart Homes," in *Advances in Intelligent Systems and Computing*, Springer International Publishing, 2017, pp. 1000–1008, doi: 10.1007/978-3-319-61566-0\_94.
- [21] M. S. Soliman *et al.*, "Supervisory energy management of a hybrid battery/PV/tidal/wind sources integrated in DC-microgrid energy storage system," *Energy Reports*, vol. 7, pp. 7728–7740, Nov. 2021, doi: 10.1016/j.egy.2021.11.056.
- [22] P. Sreekumar, M. A. R. A. Alhosani, and V. Khadkikar, "ANN Based Power Management Strategy for Standalone Microgrids," in *IECON 2021–47th Annual Conference of the IEEE Industrial Electronics Society*, 2021, doi: 10.1109/iecon48115.2021.9589534.
- [23] S. Kumaravel and S. Ashok, "Adapted multilayer feedforward ANN based power management control of solar photovoltaic and wind integrated power system," in *ISGT2011-India*, Dec. 2011, doi: 10.1109/iset-india.2011.6145386.
- [24] H. Shahinzadeh, A. Gheiratmand, S. H. Fathi, and J. Moradi, "Optimal design and management of isolated hybrid renewable energy system (WT/PV/ORES)," in *2016 21st Conference on Electrical Power Distribution Networks Conference (EPDC)*, Apr. 2016, doi: 10.1109/epdc.2016.7514808.
- [25] "Photovoltaic system performance monitoring. Guidelines for measurement, data exchange and analysis," *The Gambia Standards Bureau*, 2017, doi: 10.3403/01549027u.

## BIOGRAPHIES OF AUTHORS





**Syafii**    received a B.Sc degree in electrical engineering from the University of North Sumatera, in 1997 and M.T. degree in electrical engineering from Bandung Institute of Technology, Indonesia, in 2002 and a Ph.D. degree from Universiti Teknologi Malaysia in 2011. He is currently a senior lecturer in the Department of Electrical Engineering, Universitas Andalas, Indonesia. His research interests are new and renewable energy, smart grid, and power system computation. He can be contacted at email: syafii@eng.unand.ac.id.



**Muhandika**    received a Bachelor of Applied Science degree in electrical engineering from the Padang State University in 2015 and M.T. degree in electrical engineering from Andalas University, Indonesia in 2021. He is currently a research assistant in the Dept. of Electrical Engineering, Universitas Andalas, Indonesia. His research interests are new and renewable energy, smart grid, and power system. He can be contacted at email: muhandika17@gmail.com.



**Heru Dibyo Laksono**    received a B.Sc degree in electrical engineering from the Universitas Andalas, in 2000 and M.T. degree in electrical engineering from Bandung Institute of Technology, Indonesia, in 2004. He is currently a lecturer in the Department of Electrical Engineering, Universitas Andalas, Indonesia. His research interests are power system control, smart grid, and power system computation. He can be contacted at email: herudl@eng.unand.ac.id.